



**MATERIALI E ACCESSORI VARI
PER STAZIONI SCIISTICHE**

SKI STATION ITEMS AND ACCESSORIES



**MATERIAL UND ZUBEHÖR
FÜR WINTERSPORTGEBIETE**



Courmayeur

RETE ANTICADUTA PER ZONA D'ARRIVO SEGGIOVIE SAFETY PROTECTION NET FOR AREA OF ARRIVAL OF CHAIRLIFTS SICHERHEITS / FANGNETZ FÜR SESSELLIFTE

Rete in treccia di nylon alta tenacità, stabilizzato ai raggi UV, idrorepellente, termofissato, lavorazione senza nodo, completa di corda perimetrale

Net in high tenacity nylon, UV stabilized, water-repellent, thermofixed, not knotted, completed with perimetral rope

Netze aus extra starkem nylon UV-stabilisiert, wasserdicht, thermofixiert, ohne Knoten Arbeiten, komplett mit Perimeter-Randverstärkung

Treccia: Ø 5 mm
Maglia: 10x10 cm
Spezzioni confezionabili a misura
Colori disponibili: bianco
Peso: 160 g/m²

Plait: Ø 5 mm
Mesh: 10x10 cm
Pieces can be made to measure
Available colors: white
Weight: 160 g/m²

Kordel: Ø 5 mm
Maschenweite: 10x10 cm
Maße auf Anfrage
Farben: weiß
Gewicht: 160 g/m²

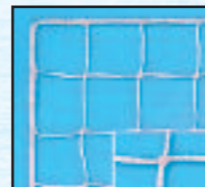

Cod.
Antic.NCERTIF

RETE ANTICADUTA PER "ZONA D'ARRIVO SEGGIOVIE" CERTIFICATA SAFETY PROTECTION NET APPROVED FOR AREA OF ARRIVAL OF CHAIRLIFTS SICHERHEITS / FANGNETZ GENEHMIGT FÜR SESSELLIFTE

Rete in polietilene stabilizzato ai raggi UV, idrorepellente, termofissato, lavorazione con nodo, completa di corda perimetrale, omologata secondo la normativa EN 1263-1, completa di sigilli per il rinnovo annuale di collaudo

Net in UV stabilized polyethylene, water-repellent, thermofixed, knotted, completed with perimetral rope, approved according to EN 1263-1, completed with seals for the annual renewal inspection

Netze aus Polyäthylene UV-stabilisiert, wasserdicht, thermofixiert, Knoten Arbeiten, komplett mit Perimeter-Randverstärkung, genehmigt nach EN 1263-1, komplett mit Dichtungen für die jährliche Erneuerung der Prüfung

Treccia: Ø 5 mm
Maglia: 10x10 cm
Spezzioni confezionabili a misura
Colori disponibili: verde, rosso, blu
Peso: 240 g/m²

Plait: Ø 5 mm
Mesh: 10x10 cm
Pieces can be made to measure
Available colors: green, red, blue
Weight: 240 g/m²

Kordel: Ø 5 mm
Maschenweite: 10x10 cm
Maße auf Anfrage
Farben: grün, rot, blau
Gewicht: 240 g/m²

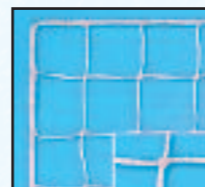
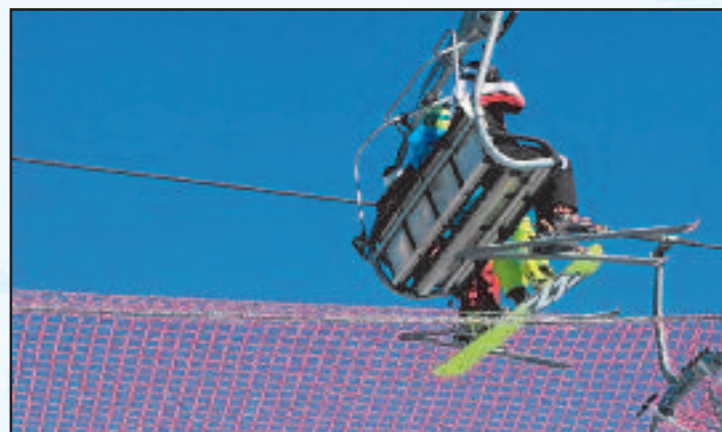

Cod.
Antic.CERTIF

TRIANGOLI DI PROTEZIONE TRIANGULAR PROTECTIONNET / DREIECK-SCHUTZNETZ

materiale: polietilene
finitura: annodata, completa di cordino perimetrale e termofissata
maglia: 7x7 cm
treccia: Ø 5mm – Ø 3.5 mm
base 6 m x altezza 6 m
Colori: rosso o blu

material: polyethylene
finishing: knotted, completed with perimetral rope and hot joined mesh
sizes: 7x7 cm
plait size: Ø 5 mm – Ø 3.5 mm
base 6 m x height 6 m
colours: red or blue

Material: Polyethylen
Knoten Arbeiten, komplett mit Perimeter-Randverstärkung, thermofixiert
Maschenweite: 7x7 cm
Kordel: Ø 5 mm – Ø 3.5 mm
Basis 6 m x Höhe 6 m
Farben: rot oder blau



Cod. Triang

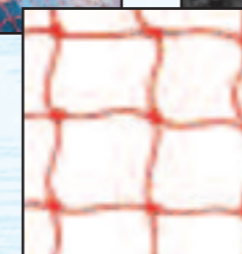

TAPPETO DI SCORRIMENTO / RUNNING CARPET / GLEITTEPPICH

Tappeto per passaggi in zona imbarco funivie
Dimensioni mt 1 x 1.50

Carpet for steps in boarding area chairlifts
Sizes mt 1 x 1.50

Teppich für die Schritte in Boarding-Bereich Seilbahnen
Maße mt 1x 1.50

Cod. tappeto

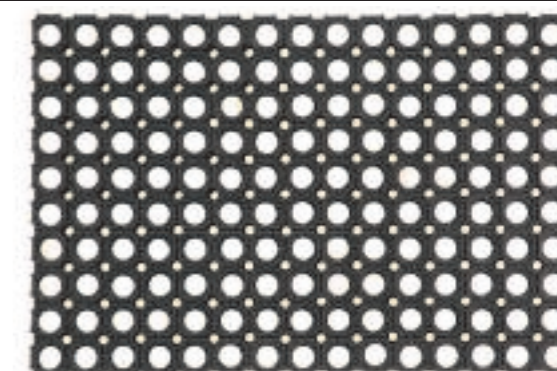

ANCORAGGIO PER GATTO CON VERRICELLO ANCHORAGE FOR SNOWCAT WITH WINCH ANKER FÜR PISTENBULLY MIT WINDE

Evita al cavo di affondare nella neve, permettendo un facile riavvolgimento

Avoid the cable to sink in the snow, allowing easy rewind

Verhindert das Versinken des Seils im Schnee und ermöglicht ein einfaches Aufwickeln

Cod. ancor.ft

Modello fuori terra / Above ground model / Modell über dem Boden

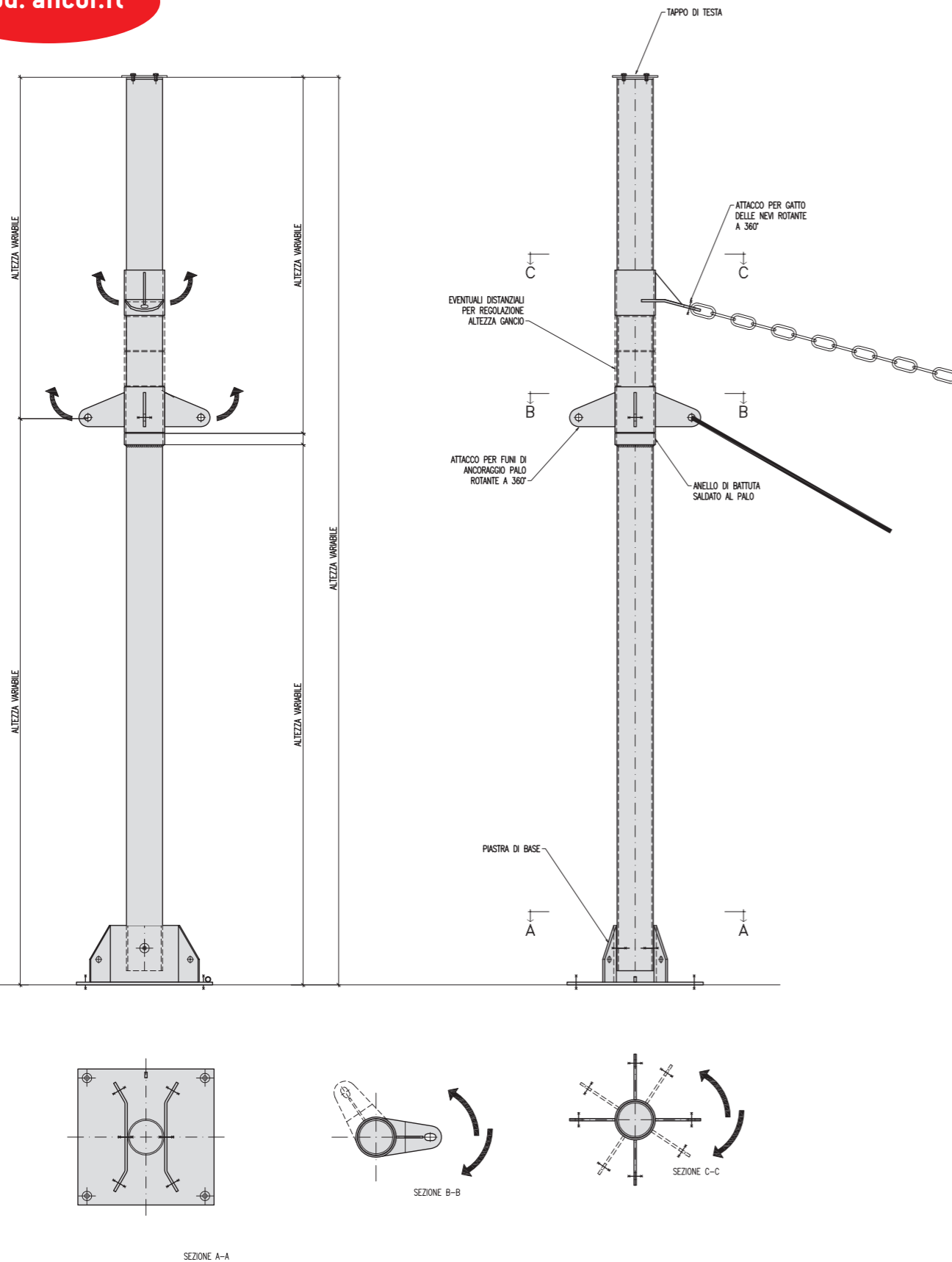

**ANCORAGGIO PER GATTO CON VERRICELLO
ANCHORAGE FOR SNOWCAT WITH WINCH
ANKER FÜR PISTENBULLY MIT WINDE**

Evita al cavo di affondare nella neve,
permettendo un facile riavvolgimento

Avoid the cable to sink in the snow,
allowing easy rewind

Verhindert das Versinken des Seils im
Schnee und ermöglicht ein einfaches
Aufwickeln

Cod. ancor.inter

Modello interrato / Underground model - Unterirdisches Modell

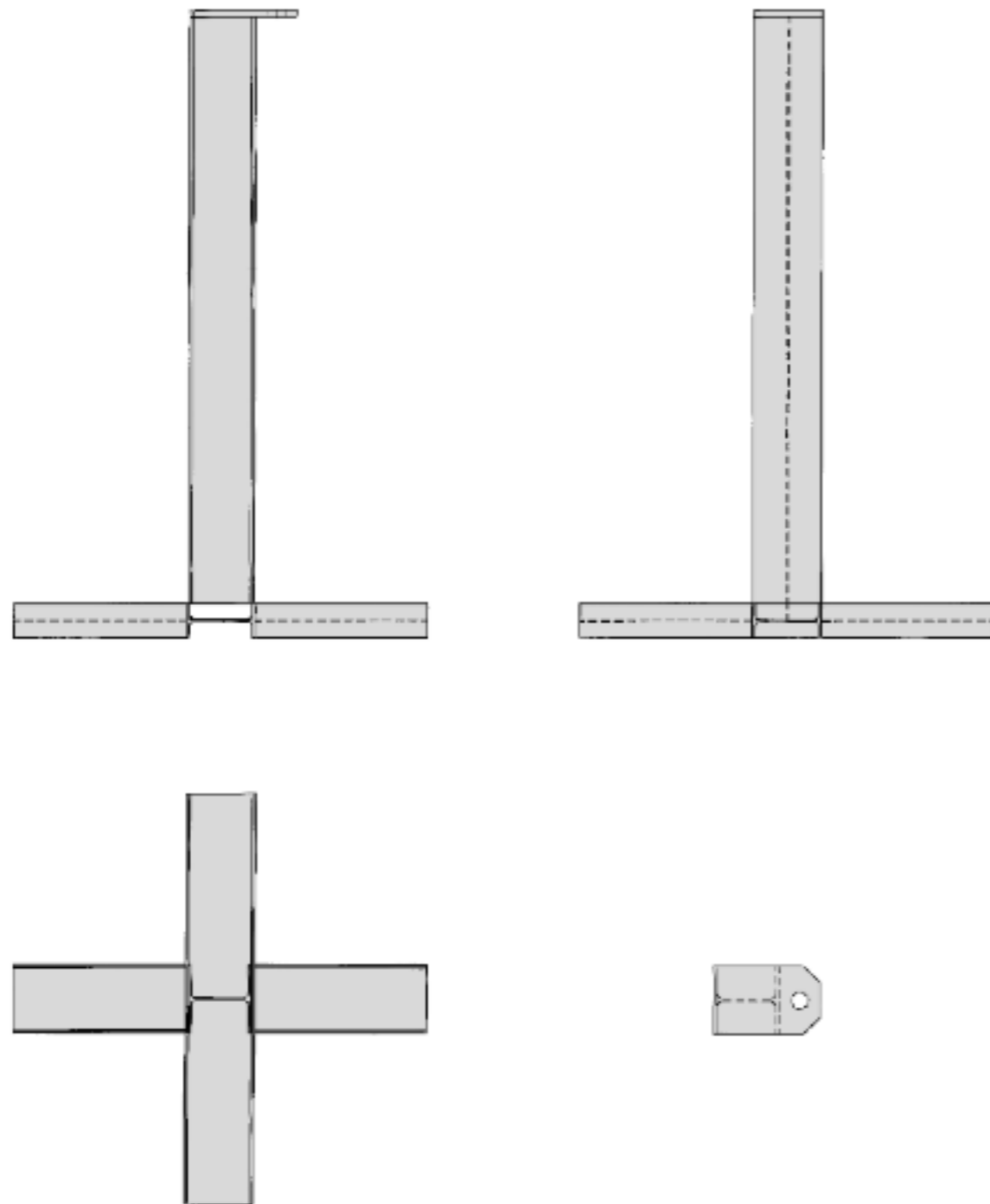

ACCESSORI PER ALLESTIMENTO GARE

ACCESSORIES FOR SKI RACES

ZUBEHÖR FÜR SKI-RENNEN